

Stand-By	Picture-On	Picture-Off	Picture-Off
Orange	White	White	Green
Red	White	Green	

LOC. NO	USED	NOT USED	ATTEN.
RD01	TTX	W/O-TTX	
RD02	AV1-AV2	AV1	
RD03	SECAM-L		
RD04	W/O-TX-PEAKING	WITH-PEAKING	
RD05	PSEUDO FLOW	LIST	

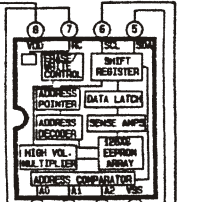

TTX OPTION-PARTS

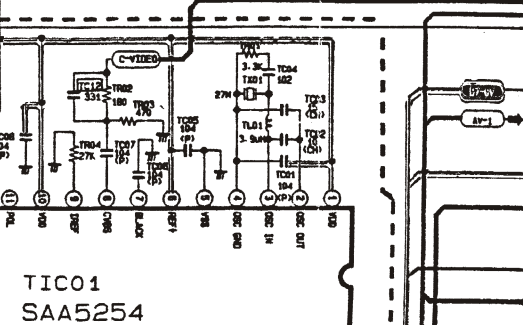

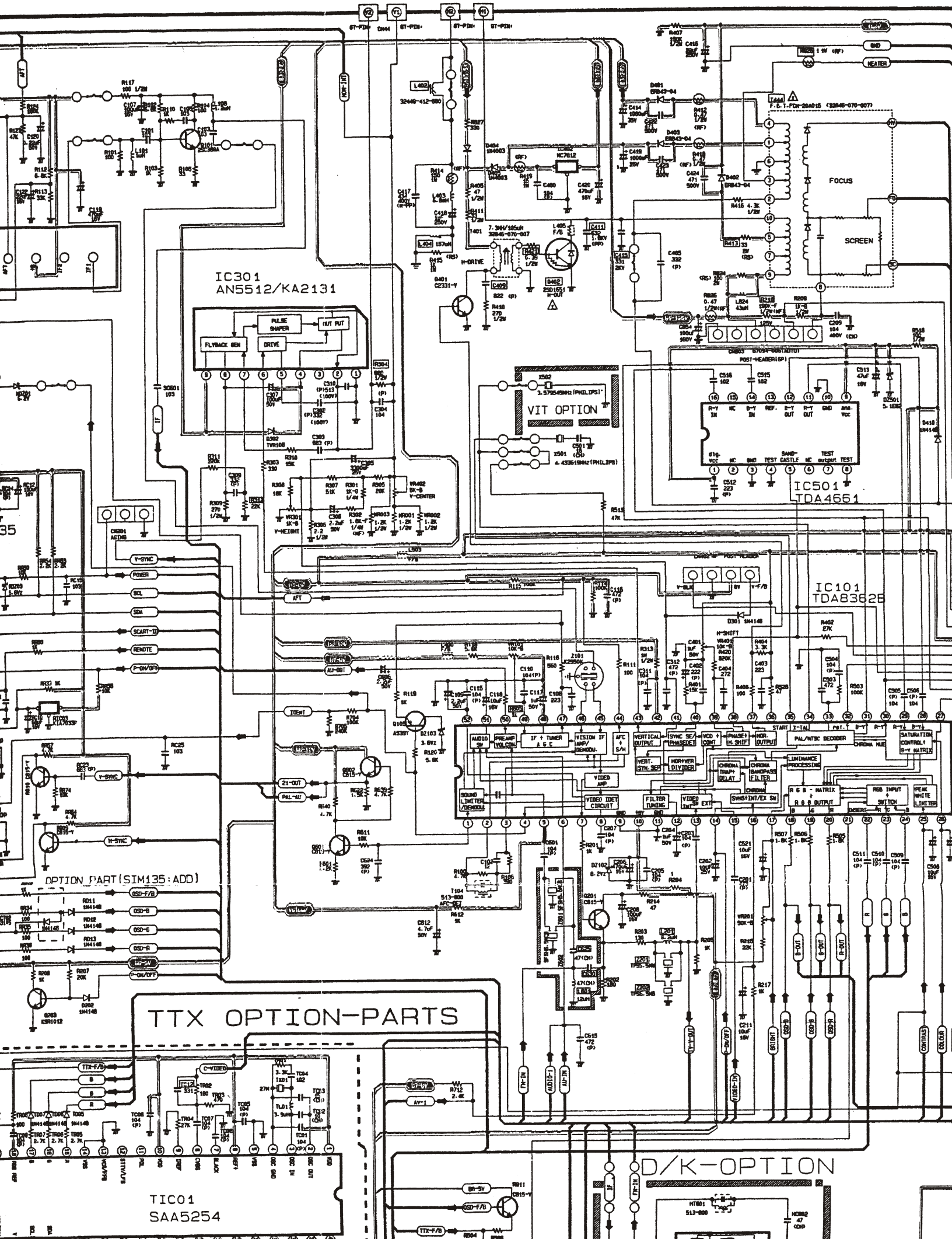

IC301  
AN5512/KA2131

VIT OPTION

IC501  
TDA4661

IC101  
TDA8362B

TTX OPTION-PARTS

TIC01  
SAA5254

D/K-OPTION

Y-SYNC  
POWER  
SCL  
SOL  
SCART-II  
REMOTE  
P-DW/VP

OPTION PART (SIM135:ADD)  
DSD-F/B  
DSD-B  
DSD-C  
DSD-R  
DSD-V  
DSD-W/VP

TTX-F/B  
C-VIEW  
TIC01  
SAA5254  
TIC01  
SAA5254

AV-1  
DSD-F/B  
TTX-F/B

AV-1  
DSD-F/B  
TTX-F/B

AV-1  
DSD-F/B  
TTX-F/B

AV-1  
DSD-F/B  
TTX-F/B

AV-1  
DSD-F/B  
TTX-F/B

AV-1  
DSD-F/B  
TTX-F/B

AV-1  
DSD-F/B  
TTX-F/B

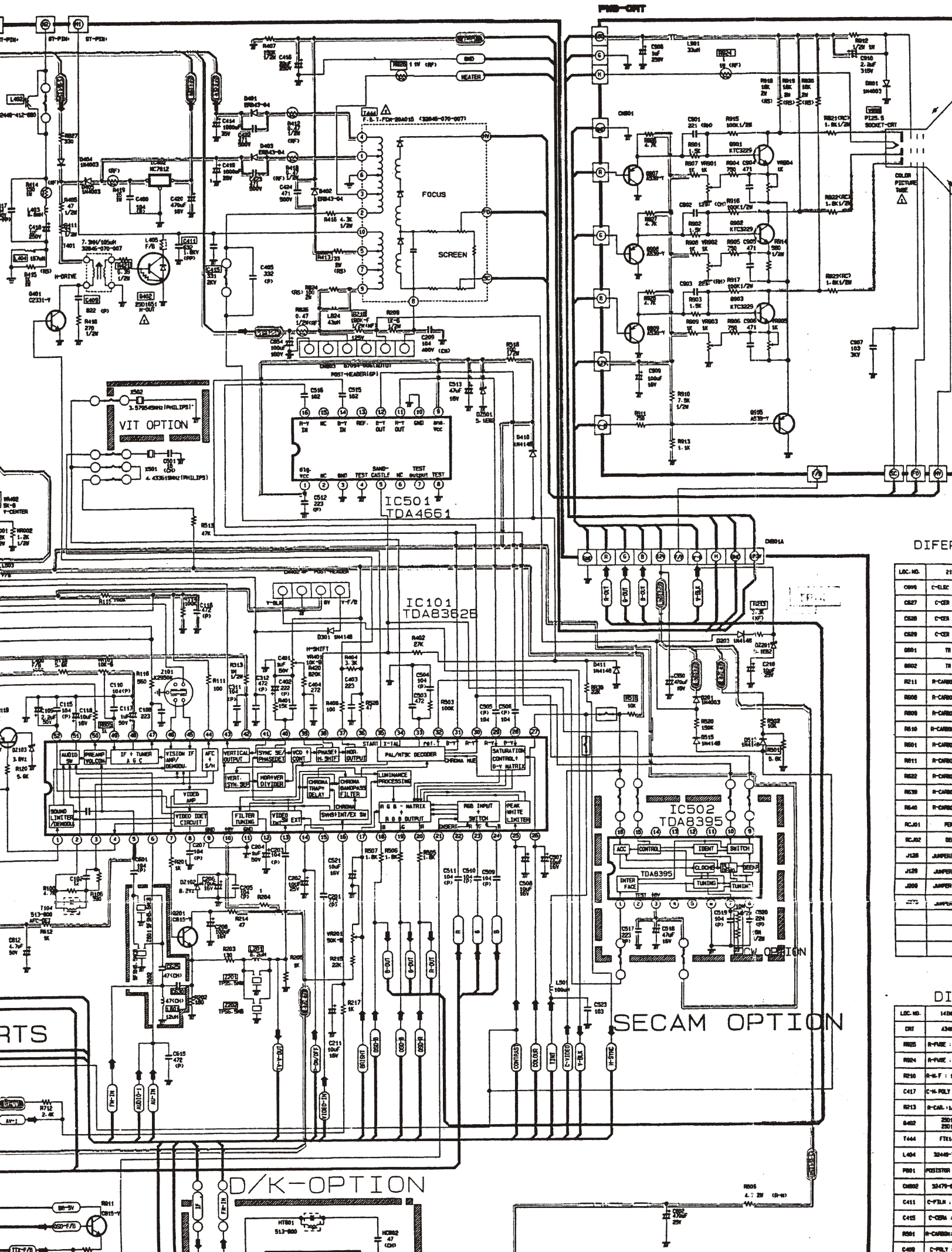

DIFER

LOC. NO.	TYPE
C009	C-ELEC
C027	C-CER
C030	C-CER
C039	C-CER
D001	TR
D002	TR
R211	R-CARBON
R008	R-CARBON
R009	R-CARBON
R010	R-CARBON
R001	R-CARBON
R011	R-CARBON
R022	R-CARBON
R039	R-CARBON
R040	R-CARBON
RC101	RELAY
RC102	RELAY
J008	JAMPER
J108	JAMPER
J006	JAMPER
C173	JAMPER

DIF

LOC. NO.	TYPE
C01	C-ALUM
R005	R-PURE
R004	R-PURE
R010	R-W.F.
C417	C-W.POLY
R013	R-CARBON
0402	250100
T404	FT104
L404	30408-70
P001	POSTITION
D002	30479-05
C415	C-F.PLM
R001	R-CARBON
C408	C-POLY

SECAM OPTION

D/K-OPTION

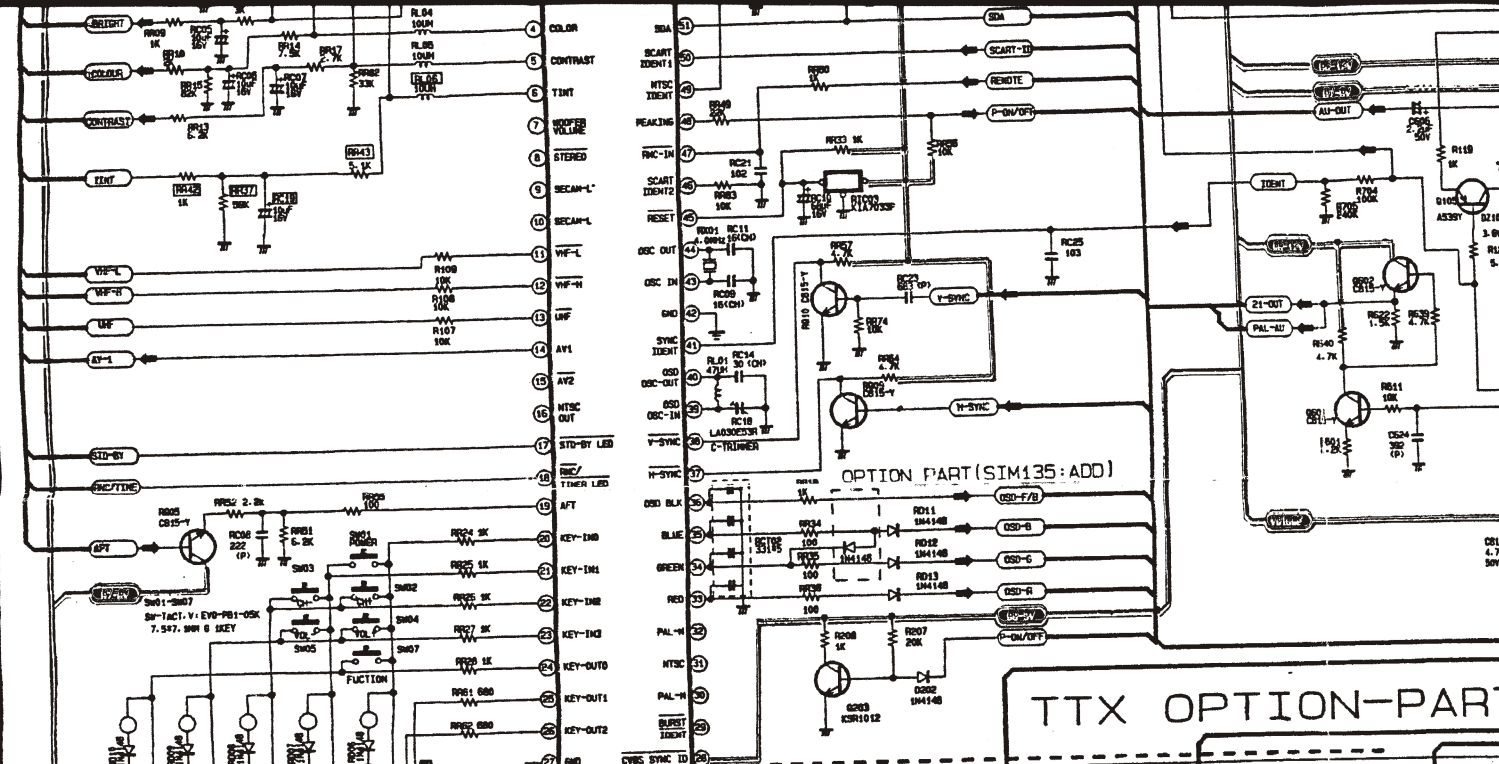

**DIODE OPTION**

LOC. NO	USED	NOT USED	ATTEN.
RD01	TTX	W/O-TTX	
RD02	AV1-AV2	AV1	
RD03	SECAM-L		
RD04	W/OUT-PEAKING	WITH-PEAKING	
RD05	PSEUDO FLOW	LIST	
RD06	MF ONLY	VL, VH, UNF	
RD07	MOOPER VOLUME		
RD08	STANDBY	DIRECT-ON	
RD09			NOT-USE
RD10	NTA 4313.381		TINT-CBS

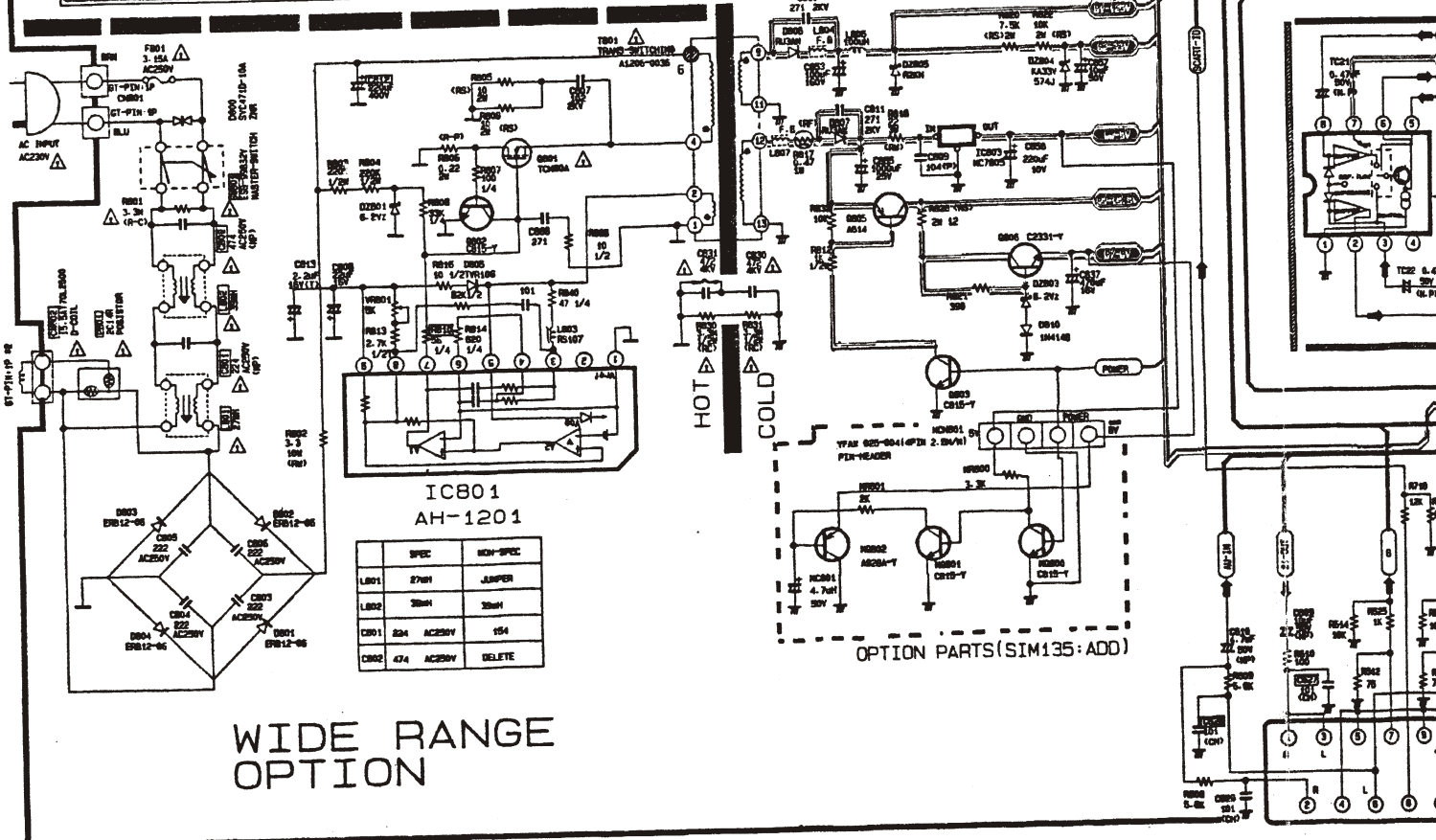
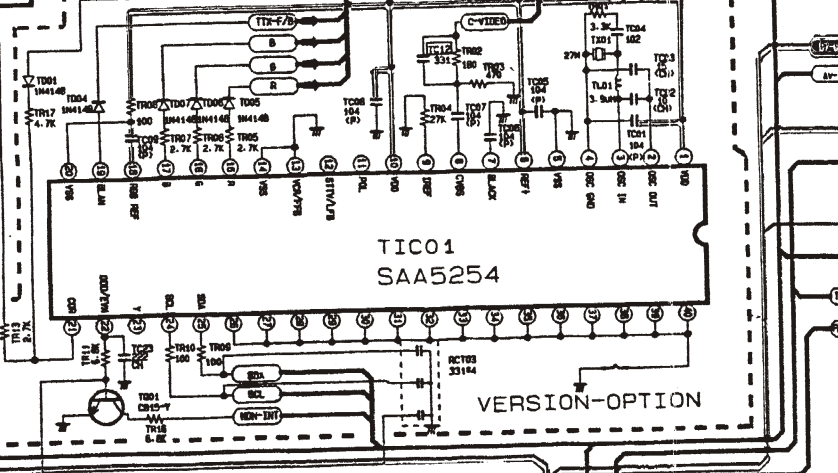
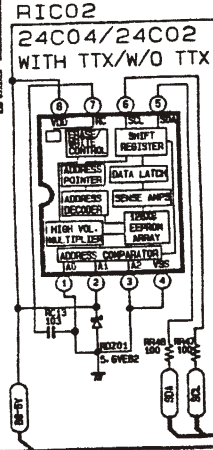



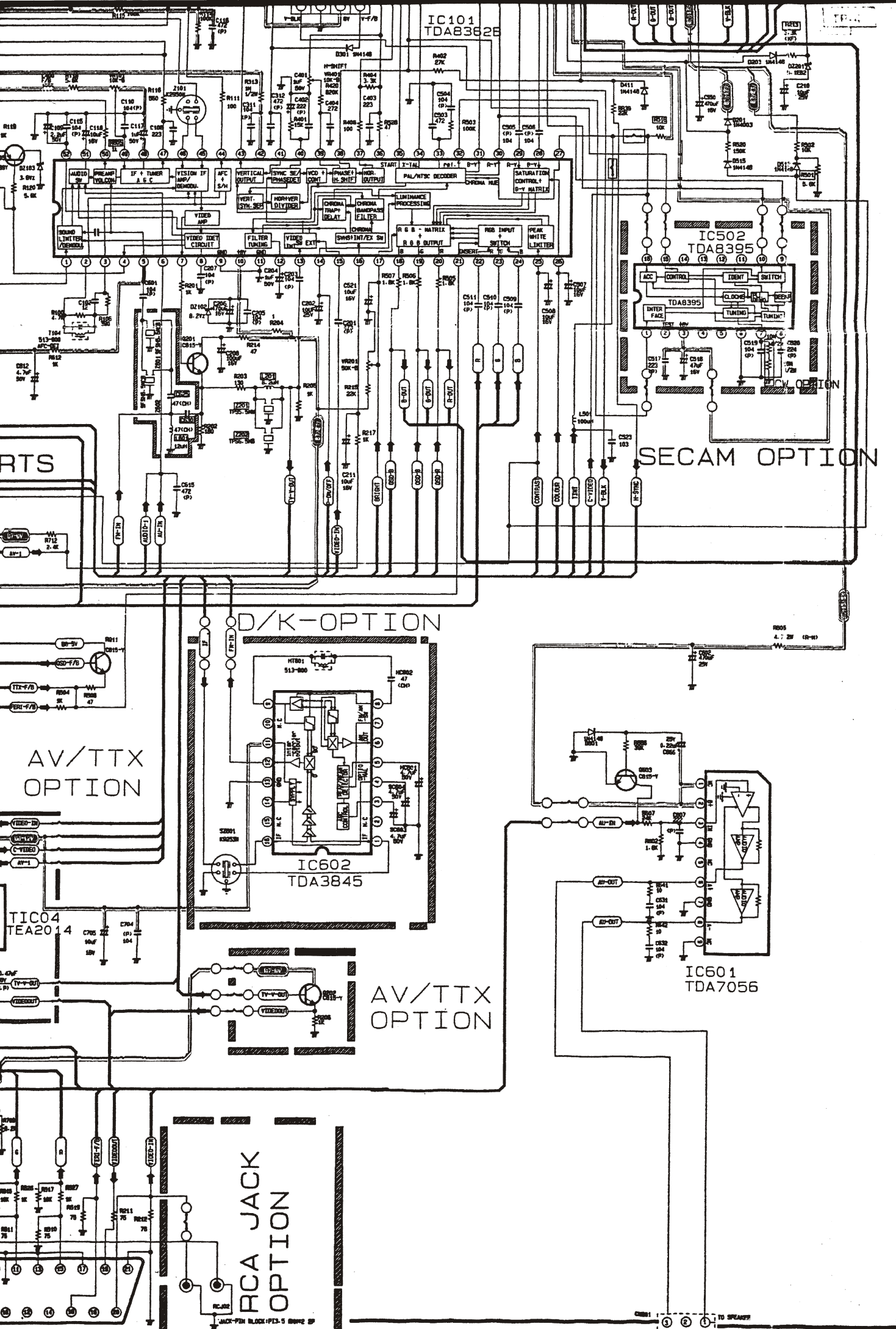

C000	C-CER
C027	C-CER
C028	C-CER
C029	C-CER
C001	TR
C002	TR
R211	R-CARBON
R000	R-CARBON
R009	R-CARBON
R010	R-CARBON
R001	R-CARBON
R011	R-CARBON
R022	R-CARBON
R030	R-CARBON
R040	R-CARBON
RC01	RES
RC02	RES
J120	JAMPER
J129	JAMPER
J000	JAMPER
C77	JAMPER

DIP	
LOC. NO.	DESCRIPTION
D07	A3000
R025	R-PULSE
R024	R-PULSE
R030	R-ALF
C417	C-H-POLY
R013	R-CAR. 1/2
Q402	2SD108
T444	FT144
L404	3240-75
R001	RESISTOR
C002	32470-02
C411	C-FILM
C415	C-CER.
R001	R-CARBON
C000	C-POLY
Y000	A3047-01
SPEAKER	85P140M
L402	JC
R411	R-CAR. 1/2
R004	R-CAR. 1/2
R421	JMP
R405	R-CAR. 1/2
R312	R-CAR. 1/2
R417	R-CAR. 1/2

RC01  
RC02  
RC03  
RC04  
RC05  
RC06  
RC07  
RC08  
RC09  
RC10  
RC11  
RC12  
RC13  
RC14  
RC15  
RC16  
RC17  
RC18  
RC19  
RC20  
RC21  
RC22  
RC23  
RC24  
RC25  
RC26  
RC27  
RC28  
RC29  
RC30  
RC31  
RC32  
RC33  
RC34  
RC35  
RC36  
RC37  
RC38  
RC39  
RC40  
RC41  
RC42  
RC43  
RC44  
RC45  
RC46  
RC47  
RC48  
RC49  
RC50  
RC51  
RC52  
RC53  
RC54  
RC55  
RC56  
RC57  
RC58  
RC59  
RC60  
RC61  
RC62  
RC63  
RC64  
RC65  
RC66  
RC67  
RC68  
RC69  
RC70  
RC71  
RC72  
RC73  
RC74  
RC75  
RC76  
RC77  
RC78  
RC79  
RC80  
RC81  
RC82  
RC83  
RC84  
RC85  
RC86  
RC87  
RC88  
RC89  
RC90  
RC91  
RC92  
RC93  
RC94  
RC95  
RC96  
RC97  
RC98  
RC99  
RC00

PWB-TRANSMITTER

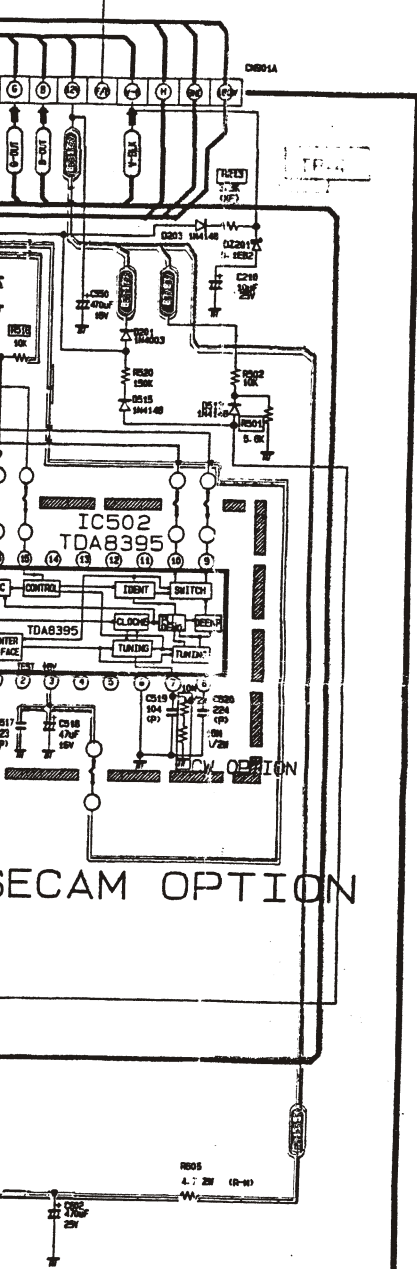
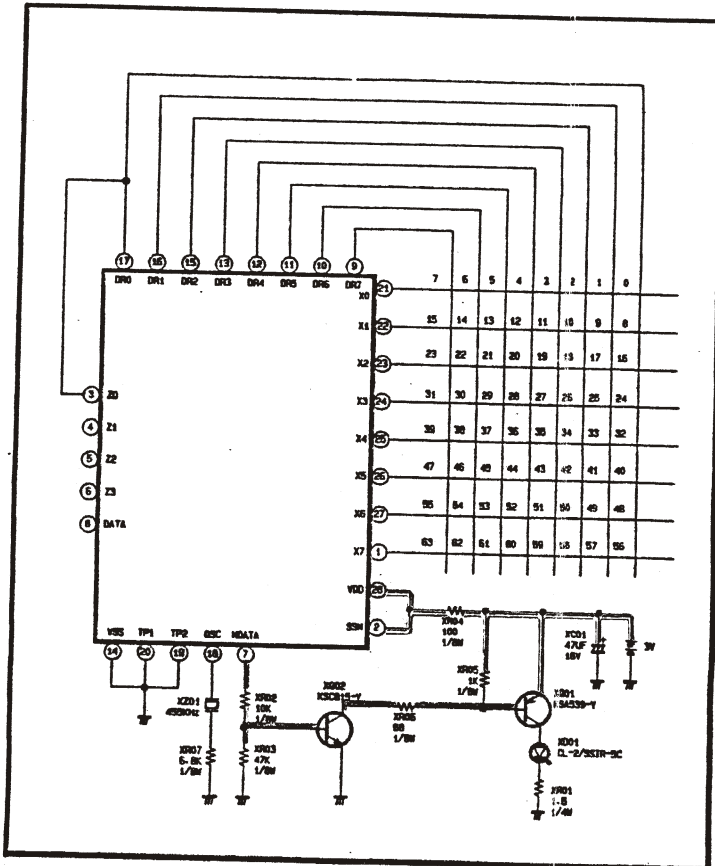
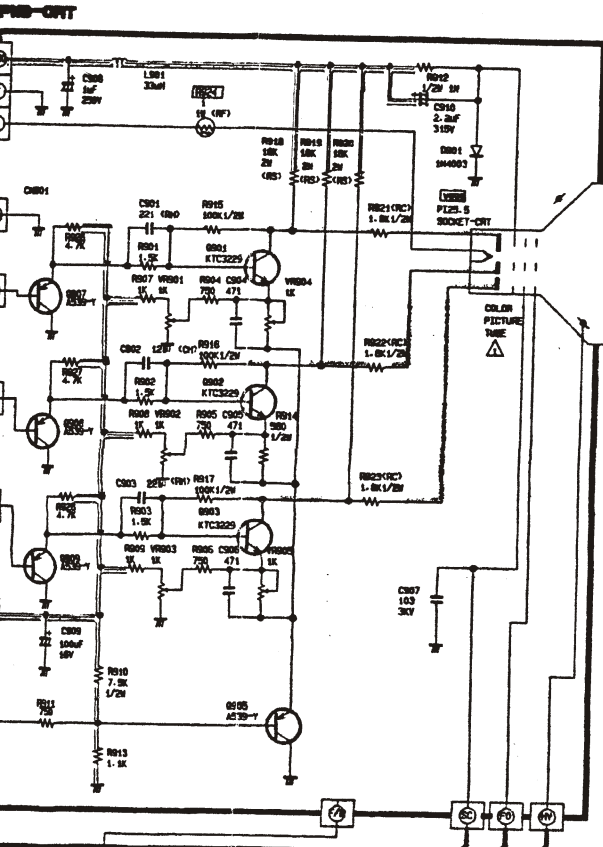

DIFERENTIAL PARTS FOR FUNCTION

LOC. NO.	21PIN JACK	A/Y INPUT JACK
C009	C-ELEC : 50V 500UF 4P	DELETE
C027	C-CER : 50V CH 101	DELETE
C028	C-CER : 50V CH 101	DELETE
C029	C-CER : 50V CH 101	DELETE
0001	TR : 0B15-7	DELETE
0002	TR : 0B15-Y	DELETE
R011	R-CARBON : 1/8T 75-J	DELETE
R008	R-CARBON : 1/8T 5-K	DELETE
R009	R-CARBON : 1/8T 5-K	DELETE
R010	R-CARBON : 1/8T 100-J	DELETE
R001	R-CARBON : 1/8T 2-K	DELETE
R011	R-CARBON : 1/8T 10K	DELETE
R022	R-CARBON : 1/8T 1.5K	DELETE
R030	R-CARBON : 1/8T 4.7K	DELETE
R040	R-CARBON : 1/8T 4.7K	DELETE
RC-01	PERI-JACK	DELETE
RC-02	DELETE	JACK-PCA 2P/A3040-01001
J128	JUMPER(0002 EMITTER)	DELETE
J129	JUMPER(21PIN FBI)	DELETE
J000	JUMPER(0302 FBI)	DELETE
J172	JUMPER(100A FBI)	JUMPER(100A FBI)

LOC. NO.	A/Y-INPUT	A/Y-DC OUTPUT
R011	DELETE	R-CARBON : 1/8T 75-J
RC-01	DELETE	A3040-0103(RCA-JACK)

LOC. NO.	REMOCON	SOFT-TOUCH
PR01	C-MODULE : SP-20W	DELETE
RC46	C-ELEC : 50V 100UF	DELETE
RC21	C-CERA : 50V 102	DELETE
R002	TR : KSR1000	DELETE
R032	R-CARBON : 1/8T 470-J	DELETE
R050	R-CARBON : 1/8T 47-J	DELETE
R050	R-CARBON : 1/8T 22K	DELETE
R050	R-CARBON : 1/8T 5K	DELETE
T/N	3F14-00000-000	DELETE

DIFERENTIAL PARTS FOR CPT

LOC. NO.	14DIN-BED	14DIN-PHILIPS	20DIN-BED	20DIN-WF	21DIN
DR1	A34004EX	A34004100G	A400002EX	A400011X16	A51K103X-10
R025	R-FUSE : 1T 1.0-J	R-FUSE : 1T 1.0-J	R-FUSE : 1T 1.0-J	R-FUSE : 1T 1.0-J	R-FUSE : 1T 1.0-J
R024	R-FUSE : 1T 0.47-J	R-FUSE : 1T 1.0-J	R-FUSE : 1T 1.0-J	R-FUSE : 1T 1.0-J	R-FUSE : 1T 1.0-J
R010	R-W.F : 1/2T 150K-F	R-W.F : 1/2T 150K-F	R-W.F : 1/2T 150K-F	R-W.F : 1/2T 150K-F	R-W.F : 1/2T 150K-F
C417	C-W.POLY : 400V 304	C-W.POLY : 400V 354	C-W.POLY : 400V 434	C-W.POLY : 400V 434	C-W.POLY : 400V 434
R013	R-CAR. 1/8T 2K-J	R-CAR. 1/8T 2K-J	R-CAR. 1/8T 3.3K-J	R-CAR. 1/8T 3.3K-J	R-CAR. 1/8T 3.3K-J
0402	2501050	2501771	K305072Y0	K305072Y0	K305072Y0
T444	FTK14A004P	FTK14A004P	FD020A015	FD020A015	FD020A015
L404	32449-730-010	32449-730-010	32449-730-040	32449-730-011	32449-730-040
P001	POSISTOR : 2C14R(D)	POSISTOR : 2C14R(D)	POSISTOR : 2C14R(D)	POSISTOR : 2C14R(D)	POSISTOR : 2C14R(D)
C0002	32479-020-300	32479-020-300	A1149-0011-FREEVOLT	A1149-0011-FREEVOLT	A1149-0010-FREEVOLT
C411	C-FILM : 1.0KV 632	C-FILM : 1.0KV 722	C-FILM : 1.0KV 632	C-FILM : 1.0KV 722	C-FILM : 1.0KV 632
C411	C-CERA : 2KV 601	C-CERA : 2KV 331	DELETE	C-CERA : 2KV 331	C-CERA : 2KV 331
R001	R-CARBON 1/8T 5-K	R-CARBON 1/8T 3-K	R-CARBON 1/8T 5-K	R-CARBON 1/8T 5-K	R-CARBON 1/8T 5-K
C408	C-POLY : 63V 103	C-POLY : 63V 103	C-POLY : 63V22J	C-POLY : 63V22J	C-POLY : 63V22J

LOC. NO.	PH-9/2
C123	C-ELEC:50V 0.47UF
C124	C-ELEC:50V 0.47UF
C125	C-ELEC:50V 0.47UF
L204	COIL-PEAK : 8.2M
L004	COIL-PEAK : 12M
0002	TR : KSA 530Y
0103	TR : KSA 530Y
0104	TR : KSA 530Y
R107	R-CARBON : 1/8T 10K
R108	R-CARBON : 1/8T 10K
R109	R-CARBON : 1/8T 10K
R005	DELETE
Z101	FILTER-SM : 0.015UF
Z201	FILTER-CER : 10V 5.0
Z202	DELETE
Z301	FILTER-CER:0.015UF
Z302	DELETE
C017	DELETE
C018	DELETE
C019	DELETE
C020	DELETE
IC202	DELETE
TU001	DELETE
C030	C-CERA : 50V CH 101
IC202	DELETE
PH	DELETE
HC002	DELETE
HC001	DELETE
HC001	DELETE
SC003	DELETE
SC004	DELETE
HT001	DELETE
SC001	DELETE
SC002	DELETE
L001	DELETE
R046	R-CARBON : 1/8T 10K-J
RC10	DELETE
R010	DELETE
RL08	DELETE
RC03	DELETE
RC02	DELETE
RC07	DELETE
RC42	DELETE
RC43	DELETE
X002	DELETE
R013	R-CARBON : 1/8T 47K-J
J110	JUMPER(0305 FBI)
J108	DELETE
J215	DELETE
J216	DELETE
J219	DELETE
J021	DELETE
J020	DELETE
J132	DELETE
J001	DELETE
J007	DELETE
J109	DELETE
J111	DELETE
J113	DELETE
J005	DELETE
J002	JUMPER(0A0-SELECT)
J003	JUMPER(0A0-SELECT)
J004	JUMPER(0A0-SELECT)
TD830577-001	DELETE

DIFERENTIAL PARTS FOR SYSTEM

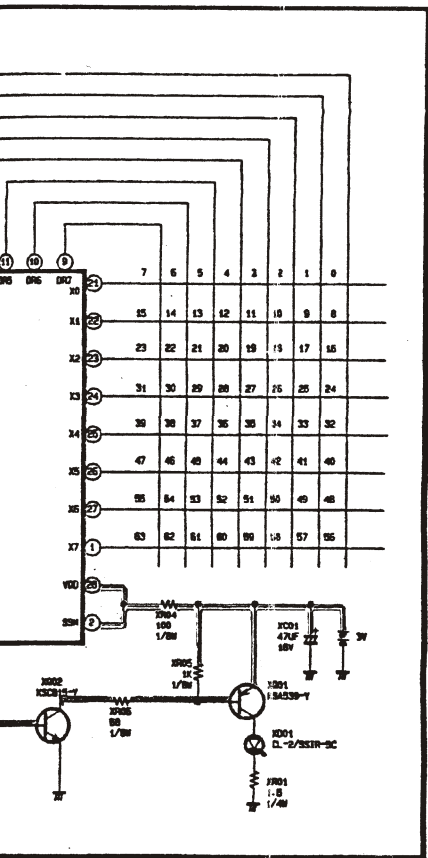

CTION

A/Y-INPUT	A/Y-DI OUTPUT
DELETE	R-CARBON : 1/8T 75-J
DELETE	43040-0103 (RCA-JACK)

REVISION	SOFT-TOUCH
HALE : 0P-00H	DELETE
EC : 50V 100UF	DELETE
EN : 50V 10K	DELETE
R : KSR100H	DELETE
OH : 1/8T 47K-J	DELETE
OH : 1/8T 47-J	DELETE
OH : 1/8T 22K	DELETE
OH : 1/8T 1K	DELETE
14-00000-000	DELETE

CPT

F	2110H
6	451K100K : 0R
	451K100K : 1.7K
0-J	R-FUSE : 1T 1.0-J
0-J	R-FUSE : 1T 1.0-J
100K-F	R-K.F : 1/2T 100K-F
0V 434	C-N.POLY : 400V 434
0	R-CAR : 1/8T 3.3K-J
0	KS0007210
5	FD0204015
011	32446-705-040
14R10	RUB1570A : 2C14R10
REVOLT	A1140-0010-FREVOLT
REVOLT	A1140-0012-FREVOLT
XY 722	C-FILM : 1.0KV 632
334	C-CERA : 20V 331
T 5.0K	R-CARBON : 1/8T 5.0K

LOC-NO	PAL-0/0	PAL/SEC-0/0	PAL/SEC-0/0-D/K	PAL-1	PAL-11	PAL/SECAN 0/0-D/K-NA-N0VIT
C123	C-ELEC : 50V 0.47UF	C-ELEC : 50V 0.47UF	C-ELEC : 50V 0.47UF	DELETE	C-ELEC : 50V 0.47UF	C-ELEC : 50V 0.47UF
C121	C-ELEC : 50V 0.47UF	C-ELEC : 50V 0.47UF	C-ELEC : 50V 0.47UF	DELETE	C-ELEC : 50V 0.47UF	C-ELEC : 50V 0.47UF
C125	C-ELEC : 50V 1UF	C-ELEC : 50V 1UF	C-ELEC : 50V 1UF	DELETE	C-ELEC : 50V 1UF	C-ELEC : 50V 1UF
L201	COIL-PEAK : 8.2MH	COIL-PEAK : 8.2MH	JUMPER	COIL-PEAK : 5.0MH	COIL-PEAK : 5.0MH	JUMPER
L801	COIL-PEAK : 12MH	COIL-PEAK : 12MH	DELETE	COIL-PEAK : 10MH	COIL-PEAK : 10MH	DELETE
0102	TR : KSA 539Y	TR : KSA 539Y	TR : KSA 539Y	DELETE	TR : KSA 539Y	TR : KSA 539Y
0103	TR : KSA 539Y	TR : KSA 539Y	TR : KSA 539Y	DELETE	TR : KSA 539Y	TR : KSA 539Y
0104	TR : KSA 539Y	TR : KSA 539Y	TR : KSA 539Y	DELETE	TR : KSA 539Y	TR : KSA 539Y
R107	R-CARBON : 1/8T 10K-J	R-CARBON : 1/8T 10K-J	R-CARBON : 1/8T 10K-J	DELETE	R-CARBON : 1/8T 10K-J	R-CARBON : 1/8T 10K-J
R108	R-CARBON : 1/8T 10K-J	R-CARBON : 1/8T 10K-J	R-CARBON : 1/8T 10K-J	DELETE	R-CARBON : 1/8T 10K-J	R-CARBON : 1/8T 10K-J
R109	R-CARBON : 1/8T 10K-J	R-CARBON : 1/8T 10K-J	R-CARBON : 1/8T 10K-J	DELETE	R-CARBON : 1/8T 10K-J	R-CARBON : 1/8T 10K-J
0005	DELETE	DELETE	DELETE	DIODE : 1M4148	DELETE	DELETE
Z101	FILTER-SAM : 0F61500H	FILTER-SAM : 0F61500H	FILTER-SAM : 0F61500H	FILTER-SAM : 0F61500H	FILTER-SAM : 0F61500H	FILTER-SAM : 0F61500H
Z001	FILTER-CER : TPS 5.0MH	FILTER-CER : TPS 5.0MH	DELETE	DELETE	DELETE	DELETE
Z002	DELETE	DELETE	DELETE	FILTER-CER : TPS 6.0MH	FILTER-CER : TPS 6.0MH	DELETE
Z001	FILTER-CER : 0F305.5MH	FILTER-CER : 0F305.5MH	FILTER-CER : 0F305.5MH	DELETE	DELETE	FILTER-CER : 0F305.5MH
Z002	DELETE	DELETE	FILTER-CER : 0F6.0MH	FILTER-CER : 0F6.0MH	FILTER-CER : 0F6.0MH	FILTER-CER : 0F6.0MH
C017	DELETE	C-POLY : 50V 223	C-POLY : 50V 223	DELETE	DELETE	C-POLY : 50V 223
C018	DELETE	C-ELEC : 10V 47UF	C-ELEC : 10V 47UF	DELETE	DELETE	C-ELEC : 10V 47UF
C019	DELETE	C-POLY : 63V 104	C-POLY : 63V 104	DELETE	DELETE	C-POLY : 63V 104
C020	DELETE	C-POLY : 63V 224	C-POLY : 63V 224	DELETE	DELETE	C-POLY : 63V 224
IC002	DELETE	IC : TM4305	IC : TM4305	DELETE	DELETE	IC : TM4305
T0001						
C030	C-CERA : 50V CH 47	C-CERA : 50V CH 47	DELETE	C-CERA : 50V CH 47	C-CERA : 50V CH 47	DELETE
IC002	DELETE	DELETE	IC : TM4305	DELETE	DELETE	IC : TM4305
PH	DELETE	DELETE	LONG-JUMPER	DELETE	DELETE	LONG-JUMPER
NC002	DELETE	DELETE	C-CERA : 50V CH 47	DELETE	DELETE	C-CERA : 50V CH 47
SC001	DELETE	DELETE	C-CERA : 50V 103	DELETE	DELETE	C-CERA : 50V 103
NC001	DELETE	DELETE	C-ELEC : 50V 4.7UF	DELETE	DELETE	C-ELEC : 50V 4.7UF
SC003	DELETE	DELETE	C-ELEC : 50V 4.7UF	DELETE	DELETE	C-ELEC : 50V 4.7UF
SC004	DELETE	DELETE	C-ELEC : 50V 4.7UF	DELETE	DELETE	C-ELEC : 50V 4.7UF
HT001	DELETE	DELETE	32717-513-000	DELETE	DELETE	32717-513-000
S001	DELETE	DELETE	FILTER-SAM : K0253H	DELETE	DELETE	FILTER-SAM : K0253H
C021	DELETE	DELETE	DELETE	DELETE	DELETE	C-CERA : 50V 103
L001	DELETE	DELETE	DELETE	DELETE	DELETE	COIL-PEAK : 1A02-101K
0516	R-CARBON : 1/8T 10K-J	R-CARBON : 1/8T 10K-J	R-CARBON : 1/8T 10K-J	R-CARBON : 1/8T 10K-J	R-CARBON : 1/8T 10K-J	DELETE
RC10	DELETE	DELETE	DELETE	DELETE	DELETE	C-ELEC : 10V 10UF
RD10	DELETE	DELETE	DELETE	DELETE	DELETE	DIODE : 1M4148
RL06	DELETE	DELETE	DELETE	DELETE	DELETE	COIL-PEAK : 1A02-100K
RD00	DELETE	DELETE	DELETE	DELETE	DELETE	R-CAR : 1/8T 2.4K
RD37	DELETE	DELETE	DELETE	DELETE	DELETE	R-CAR : 1/8T 50K
RD42	DELETE	DELETE	DELETE	DELETE	DELETE	R-CAR : 1/8T 5K
RD43	DELETE	DELETE	DELETE	DELETE	DELETE	R-CAR : 1/8T 5.1K
RS02	DELETE	DELETE	DELETE	DELETE	DELETE	X-TAL : 3.579545
RS13	R-CARBON : 1/8T 47K-J	R-CARBON : 1/8T 47K-J	R-CARBON : 1/8T 47K-J	R-CARBON : 1/8T 47K-J	R-CARBON : 1/8T 47K-J	DELETE
J110	JUMPER (0305F10)	JUMPER (0305F10)	JUMPER (0305F10)	JUMPER (0305F10)	JUMPER (0305F10)	DELETE
J100	DELETE	DELETE	DELETE	DELETE	DELETE	JUMPER (1000H6)
J015	DELETE	DELETE	DELETE	DELETE	DELETE	JUMPER (1000H6)
J016	DELETE	DELETE	DELETE	DELETE	DELETE	JUMPER (0305F10)
J019	DELETE	DELETE	DELETE	DELETE	DELETE	JUMPER (0305F10)
J021	DELETE	DELETE	DELETE	DELETE	DELETE	JUMPER (0305F10)
J020	DELETE	DELETE	DELETE	DELETE	DELETE	JUMPER (0305F10)
J102	DELETE	DELETE	JUMPER (K0253 INPUT LINE)	DELETE	DELETE	JUMPER (K0253 INPUT LINE)
J001	DELETE	DELETE	JUMPER	DELETE	DELETE	JUMPER
J00F	DELETE	DELETE	JUMPER	DELETE	DELETE	JUMPER
J100	DELETE	DELETE	JUMPER (0305F10)	DELETE	DELETE	JUMPER (0305F10)
J111	DELETE	DELETE	JUMPER (0305F10)	DELETE	DELETE	JUMPER (0305F10)
J113	DELETE	DELETE	JUMPER (0305F11)	DELETE	DELETE	JUMPER (0305F11)
J105	DELETE	DELETE	DELETE	JUMPER	JUMPER	DELETE
J002	JUMPER (BAND-SELECT)	JUMPER (BAND-SELECT)	JUMPER (BAND-SELECT)	DELETE	DELETE	JUMPER (BAND-SELECT)
J003	JUMPER (BAND-SELECT)	JUMPER (BAND-SELECT)	JUMPER (BAND-SELECT)	DELETE	DELETE	JUMPER (BAND-SELECT)
J004	JUMPER (BAND-SELECT)	JUMPER (BAND-SELECT)	JUMPER (BAND-SELECT)	DELETE	DELETE	JUMPER (BAND-SELECT)
TM43057-000	DELETE	DELETE	DELETE	DELETE	DELETE	R-CARBON : 1/8T 10K 1/2



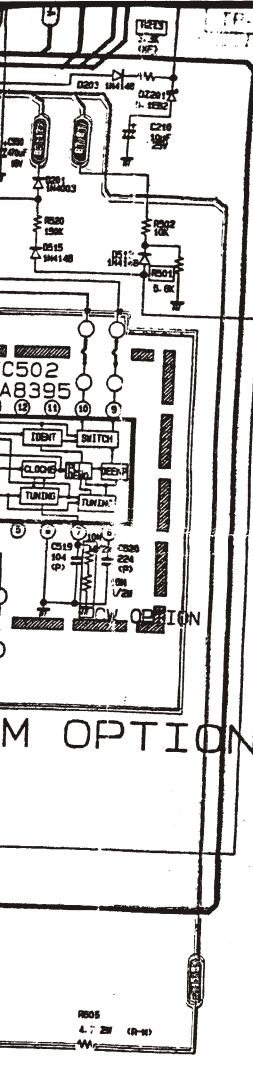

CB27	C-CER : 50V CH 501	DELETE
CB28	C-CER : 50V CH 501	DELETE
CB29	C-CER : 50V CH 101	DELETE
CB31	TR : CB15-Y	DELETE
CB32	TR : CB15-Y	DELETE
RC11	R-CARBON : 1/8T 75-J	DELETE
RC16	R-CARBON : 1/8T 5.8K	DELETE
RC17	R-CARBON : 1/8T 5.8K	DELETE
RC18	R-CARBON : 1/8T 100-J	DELETE
RC19	R-CARBON : 1/8T 2.2K	DELETE
RC20	R-CARBON : 1/8T 50K	DELETE
RC21	R-CARBON : 1/8T 1.5K	DELETE
RC22	R-CARBON : 1/8T 4.7K	DELETE
RC23	R-CARBON : 1/8T 4.7K	DELETE
RC24	R-CARBON : 1/8T 4.7K	DELETE
RC31	PERI-JACK	DELETE
RC32	DELETE	JACK-PCA 2P(A3040-0180)
J128	JUMPER(B322 5LITER)	DELETE
J129	JUMPER(21P2H 101)	DELETE
J200	JUMPER(B322 711)	DELETE
J272	JUMPER(1110M F01)	JUMPER(1110M F01)

RC31	DELETE	R-CARBON : 1/8T 75-J
RC32	DELETE	A3040-0180(PCA-JACK)
LOC. NO.	REVISION	SOFT-TOUCH
PR01	MIDDLE : SP-20H	DELETE
RC16	C-ELEC : 50V 100uF	DELETE
RC21	C-CER : 50V 100	DELETE
RC32	TR : KSR1009	DELETE
RC33	R-CARBON : 1/8T 470-J	DELETE
RC34	R-CARBON : 1/8T 47-J	DELETE
RC35	R-CARBON : 1/8T 22K	DELETE
RC36	R-CARBON : 1/8T 1K	DELETE
T/W	3F14-00011-000	DELETE

RC16	R-CARBON : 1/8T 50-J	R-CARBON : 1/8T
RC18	DELETE	DELETE
RC19	DELETE	DELETE
RC20	DELETE	DELETE
RC21	DELETE	DELETE
RC22	DELETE	DELETE
RC23	DELETE	DELETE
RC24	DELETE	DELETE
RC25	DELETE	DELETE
RC26	DELETE	DELETE
RC27	DELETE	DELETE
RC28	DELETE	DELETE
RC29	DELETE	DELETE
RC30	DELETE	DELETE
RC31	DELETE	DELETE
RC32	DELETE	DELETE
RC33	DELETE	DELETE
RC34	DELETE	DELETE
RC35	DELETE	DELETE
RC36	DELETE	DELETE
RC37	DELETE	DELETE
RC38	DELETE	DELETE
RC39	DELETE	DELETE
RC40	DELETE	DELETE
RC41	DELETE	DELETE
RC42	DELETE	DELETE
RC43	DELETE	DELETE
RC44	DELETE	DELETE
RC45	DELETE	DELETE
RC46	DELETE	DELETE
RC47	DELETE	DELETE
RC48	DELETE	DELETE
RC49	DELETE	DELETE
RC50	DELETE	DELETE
RC51	DELETE	DELETE
RC52	DELETE	DELETE
RC53	DELETE	DELETE
RC54	DELETE	DELETE
RC55	DELETE	DELETE
RC56	DELETE	DELETE
RC57	DELETE	DELETE
RC58	DELETE	DELETE
RC59	DELETE	DELETE
RC60	DELETE	DELETE
RC61	DELETE	DELETE
RC62	DELETE	DELETE
RC63	DELETE	DELETE
RC64	DELETE	DELETE
RC65	DELETE	DELETE
RC66	DELETE	DELETE
RC67	DELETE	DELETE
RC68	DELETE	DELETE
RC69	DELETE	DELETE
RC70	DELETE	DELETE
RC71	DELETE	DELETE
RC72	DELETE	DELETE
RC73	DELETE	DELETE
RC74	DELETE	DELETE
RC75	DELETE	DELETE
RC76	DELETE	DELETE
RC77	DELETE	DELETE
RC78	DELETE	DELETE
RC79	DELETE	DELETE
RC80	DELETE	DELETE
RC81	DELETE	DELETE
RC82	DELETE	DELETE
RC83	DELETE	DELETE
RC84	DELETE	DELETE
RC85	DELETE	DELETE
RC86	DELETE	DELETE
RC87	DELETE	DELETE
RC88	DELETE	DELETE
RC89	DELETE	DELETE
RC90	DELETE	DELETE
RC91	DELETE	DELETE
RC92	DELETE	DELETE
RC93	DELETE	DELETE
RC94	DELETE	DELETE
RC95	DELETE	DELETE
RC96	DELETE	DELETE
RC97	DELETE	DELETE
RC98	DELETE	DELETE
RC99	DELETE	DELETE
RC100	DELETE	DELETE

DIFERENTIAL PARTS FOR CPT

LOC. NO.	14DCH-982	14DCH-PHILIPS	20DCH-982	20DCH-WF	21DCH
CR1	A340042X	A3400106	A400002X	A4000116	A51K103X-1R A520A53X-1.7R
RC25	R-FUSE : 1T 1.0-J	R-FUSE : 1T 1.0-J	R-FUSE : 1T 1.0-J	R-FUSE : 1T 1.0-J	R-FUSE : 1T 1.0-J
RC24	R-FUSE : 1T 0.47-J	R-FUSE : 1T 1.0-J	R-FUSE : 1T 1.0-J	R-FUSE : 1T 1.0-J	R-FUSE : 1T 1.0-J
RC10	R-H.F : 1/2T 190K-F	R-H.F : 1/2T 190K-F	R-H.F : 1/2T 190K-F	R-H.F : 1/2T 190K-F	R-H.F : 1/2T 190K-F
CA17	C-H.POLY : 400V 354	C-H.POLY : 400V 354	C-H.POLY : 400V 434	C-H.POLY : 400V 434	C-H.POLY : 400V 434
RC13	R-CAR. : 1/8T 2K-J	R-CAR. : 1/8T 2K-J	R-CAR. : 1/8T 3.3K-J	R-CAR. : 1/8T 3.3K-J	R-CAR. : 1/8T 3.3K-J
B402	2301850 2301771	2301850 2301771	K325072YD	K325072YD	K325072YD
F444	FTK14004P	FTK14004P	FO2004015	FO2004015	FO2004015
.404	32449-730-010	32449-730-010	32449-705-040	32449-730-011	32449-705-040
PS01	POSTISTOR : 2C14R101	POSTISTOR : 2C14R101	POSTISTOR : 2C14R101	POSTISTOR : 2C14R101	POSTISTOR : 2C14R101
CR02	32479-029-300	32479-029-300	A1149-0011-FREEVOLT A1149-0013-220VOLT	A1149-0011-FREEVOLT A1149-0013-220VOLT	A1149-0010-FREEVOLT A1149-0012-220VOLT
CA11	C-FILM : 1.6KV 632	C-FILM : 1.6KV 722	C-FILM : 1.6KV 632	C-FILM : 1.6KV 722	C-FILM : 1.6KV 832
CA15	C-CER : 2KV 681	C-CER : 2KV 331	DELETE	C-CER : 2KV 331	C-CER : 2KV 331
RC01	R-CARBON : 1/8T 3.8K	R-CARBON : 1/8T 3.8K	R-CARBON : 1/8T 5.8K	R-CARBON : 1/8T 5.8K	R-CARBON : 1/8T 5.8K
CA08	C-POLY : 63V 953	C-POLY : 63V 953	C-POLY : 63V22J	C-POLY : 63V22J	C-POLY : 63V22J
V900	A3047-0013(H2E1)	A3047-0013(H2E1)	A3047-0010(H2E1)	A3047-0010(H2E1)	A3047-0010(H2E1)
SPEAKER	8P140R 3W 160ms	8P140R 3W 160ms	115C003A 3W 160ms	115C003A 3W 160ms	115C003A 3W 160ms
L402	JC-FER	WIDTH-COIL(412-060)	JUMPER	WIDTH-COIL(412-060)	WIDTH-COIL(412-060)
RA11	R-CAR. : 1/2T 10-J	R-CAR. : 1/2T 10-J	R-CAR. : 1/2T 33-J	R-CAR. : 1/2T 33-J	R-CAR. : 1/2T 33-J
RC04	R-CAR. : 1/2T 680-J	R-CAR. : 1/2T 330-J	R-CAR. : 1/2T 330-J	R-CAR. : 1/2T 680-J	R-CAR. : 1/2T 330-J
RA21	JUMPER	JUMPER	R-CAR. : 1/2T 0.39-J	R-CAR. : 1/2T 0.39-J	R-CAR. : 1/2T 0.39-J
RA05	R-CAR. : 1/2T 12-J	R-CAR. : 1/2T 12-J	R-CAR. : 1/2T 47-J	R-CAR. : 1/2T 47-J	R-CAR. : 1/2T 47-J
RC12	R-CAR. : 1/8T 33K-J	R-CAR. : 1/8T 33K-J	R-CAR. : 1/8T 22K-J	R-CAR. : 1/8T 22K-J	R-CAR. : 1/8T 22K-J
RC17	R-CAR. : 1/8T 5.8K-J	R-CAR. : 1/8T 5.8K-J	R-CAR. : 1/8T 2.7K-J	R-CAR. : 1/8T 2.7K-J	R-CAR. : 1/8T 2.7K-J

EXPRESSIONS  
 1 Resistor to show ohm  $\times 1,000$  or  $\times 1,000,000$   
 2 Unless otherwise noted in schematic all capacitor values less than 1 are expressed in  $\mu$ F. The values more than 1 in  $\mu$ F.  
 3 Unless otherwise noted in schematic all inductor values are expressed in  $\mu$ H and the values less than 1 in mH.

NOTE  
 The circuits are subject to change without notice to improve the picture quality.

CAPACITOR	
Ceramic - SL	No Mark
Ceramic - RH	CRD
Ceramic - CH	CRD
Polyester(Induct)	CPD
Polyester(Noninduct)	CPWJ
Polypropylene	CPP
Metal Polyester	CPP
M. P. Polypropylene	CPP
Tantalum	CT
Non Polar	CPJ

RESISTOR	
Carbon	No Mark
Composition	CRJ
Metal Oxide	CRS
Metal Film	CRD
Fusible	CRF
Cement Wire	CRW
Network	CRN